



Feed-Thru Bushing With Knockout



Features & Benefits

- For RG6 dual or quad-shield cable with or without messenger
- Available as single or dual configuration
- Beveled design ensures firm fit
- Seals wall openings to prevent water mitigation
- Damage-free design secures and protects RG6 cable through wall entry
- Provides clean cable installations sealing roughly drilled holes
- Durable UV-stabilized impact-resistant High-Density Polyethylene construction
- Available in Black
- Packaging: Bag of 100

Applications

These UV-stabilized, impact resistant feed-thru bushings secure and protect RG6 cable while enabling entry through wall openings in residential or commercial environments.

Description / Specifications

These feed-thru bushings provide a clean cable installation for RG6 dual or quad-shield coax cable and are available in a single or a dual configuration. These wall bushings, composed of a UV-stabilized High-Density Polyethylene, include optional knockouts to accommodate RG6 cable with messenger.

Ordering Information

Description	Feed-Thru Bushing With Knockout
Packaging	Bag of 100
Item Number (Single)	Item Number (Dual)
XACCM-01415	XACCM-01417

Technical Illustration

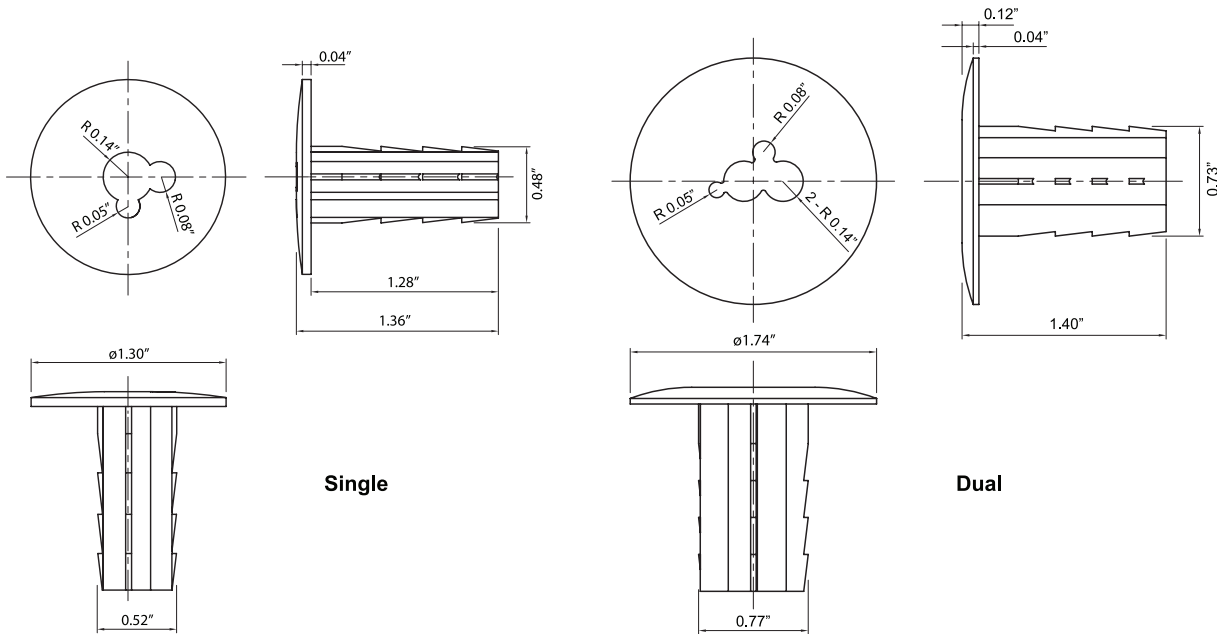

TECHNICAL SHEETS ARE SUBJECT TO CHANGE WITHOUT NOTICE.

REV.20210728.1