



RG6 Quad Shield Hex Crimp Connector



Features & Benefits

- Easy installation on any quad-shield RG6 coaxial cable with any standard hex crimping tool
- High performance F-type connector capable of a bandwidth of up to 3 GHz
- Bulk packaged in bags of 100

Construction

Material:

- (1) Nut: Nickel Plated Zinc
- (2) Liner: Nickel Plated Brass
- (3) Shell: Nickel Plated Brass

Connector Type: F-type Hex Crimp for Quad Shield RG6

Electrical

Impedance: 75Ω Voltage

Environmental Conditions

Operating Temperature: -40 °F to 140 °F (-10 °C to 60 °C)

Technical Illustration

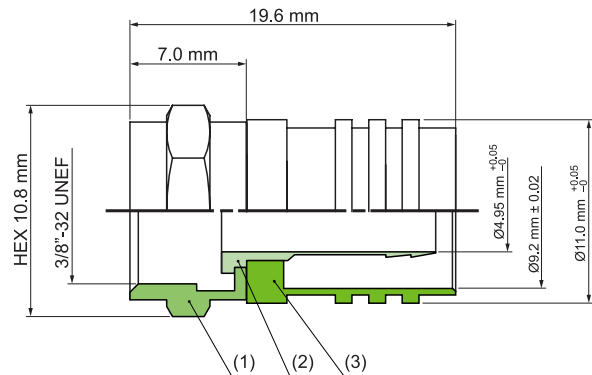

Applications

The Vericom RG6 quad shield hex crimp connector is an economical solution for terminating RG6 coaxial cable. This connector is commonly used for antenna, cable television and satellite television installations.

Description / Specifications

This RG6 quad shield hex crimp connector is made from anodized brass to provide long life, free from oxidation. The nut on this connector is larger than that on most F-connectors available which means more threads for better shielding, and a larger surface to finger-tighten the connector.

Related Products

To ensure a proper connection, pair Vericom's WCR6Q-03443 with the following:

Coax Hex Crimping Tool



Item No. WTCXC-03634

Ordering Information

Description	
F-Type Hex Crimp Connector for Quad Shield Coax Cable	
Item No.	Packaging
WCR6Q-03443	Bulk (100 Per Bag)

TECHNICAL SHEETS ARE SUBJECT TO CHANGE WITHOUT NOTICE.

REV.20230807.3