

COMPLIANCE	ANSI/EIA RS-310D IEC60297-2 DIN41494; Part 1 DIN41494; Part 7
LOADING CAPACITY	3,000 lbs static load

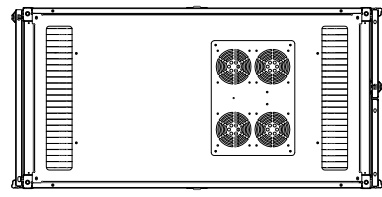

TOP VIEW

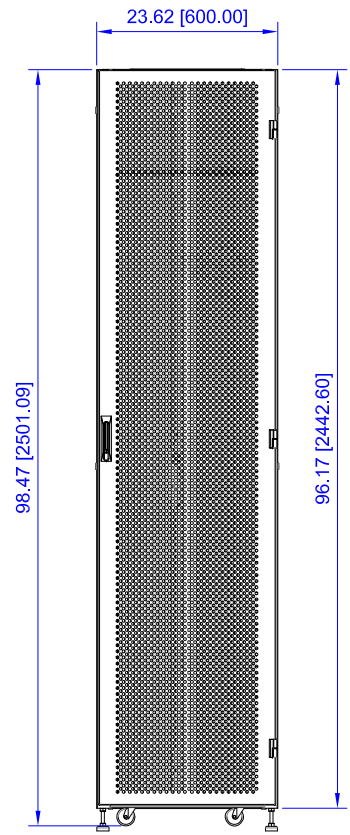
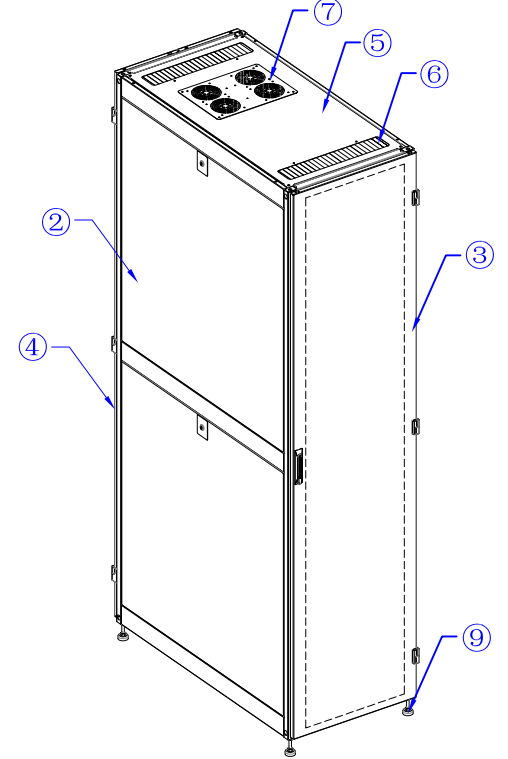
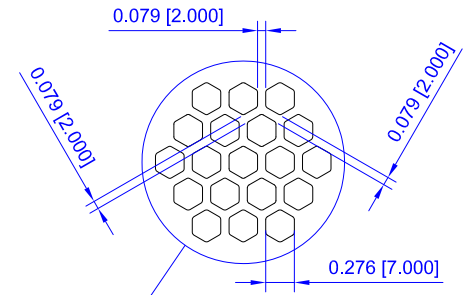

FRONT VIEW

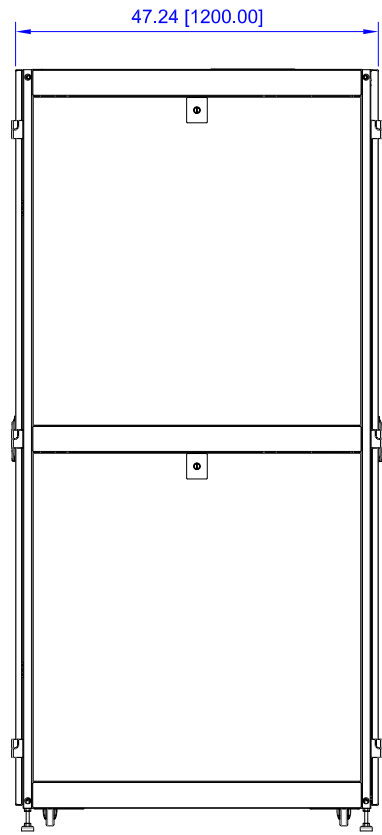

SIDE VIEW

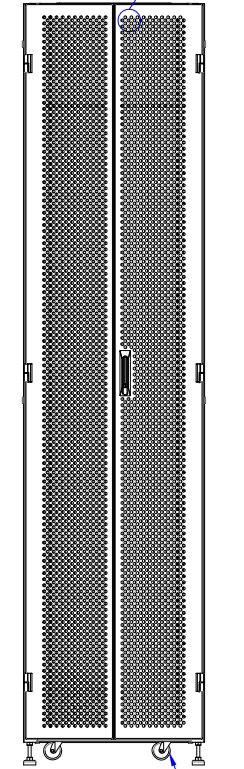

BACK VIEW

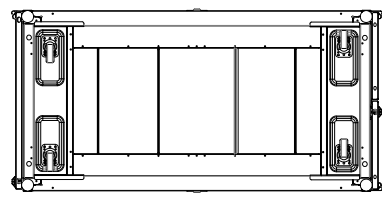

BOTTOM VIEW

All dimensions in inches [mm]

NO	QTY	NAME	MATERIAL	THICKNESS
12	2	PDU Lacing Panels	Steel	18 gauge
11	4	Cage Hole Mounting Rails	Steel	14 gauge
10	4	2.5" Dia. Casters		
9	4	Adjustable Levelers		
8	2	Adjustable Bottom Panels	Steel	18 gauge
7	1	Removable Fan Panel	Steel	18 gauge
6	2	Brush Panel Cable Entry		
5	1	Top	Steel	18 gauge
4	1	Split Panel Mesh Rear Door (standard)	Steel	18 gauge
3	1	Full Panel Mesh Front Door (standard)	Steel	18 gauge
2	4	Removable Side Panels	Steel	16 gauge
1	N/A	Cabinet Frame	Steel	18 gauge

ITEM NO. **VC5-6252-ABV1A**

DESCRIPTION **Server Cabinet, 52U x 24"W x 48"D**

DATE: 05/12/20    SCALE: none    SHEET: 1 of 2    REV: 1



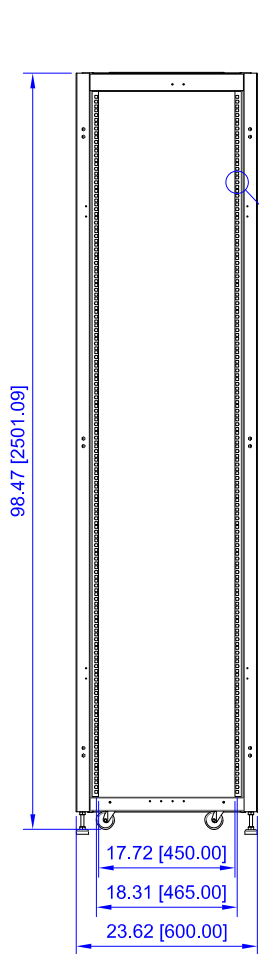

FRONT VIEW  
(NO DOOR)

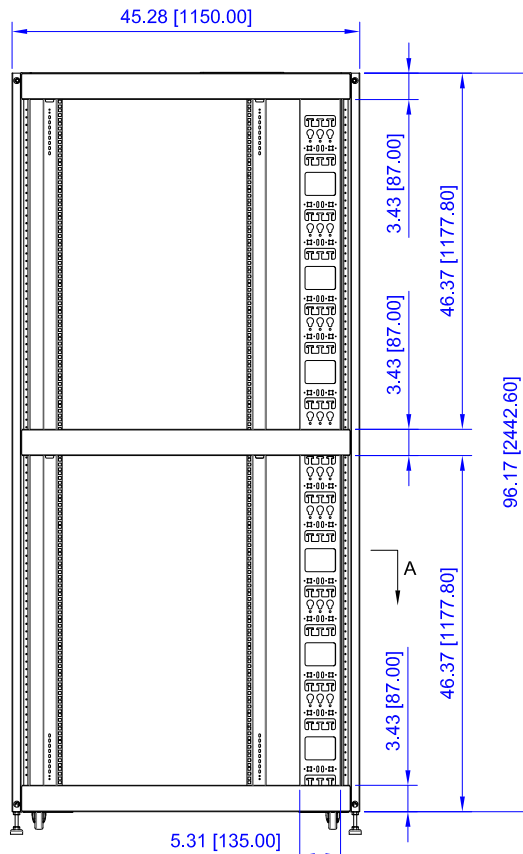
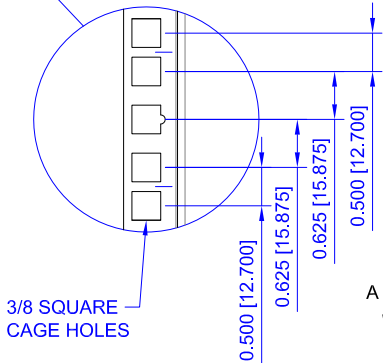

SIDE VIEW  
(NO SIDE PANELS)

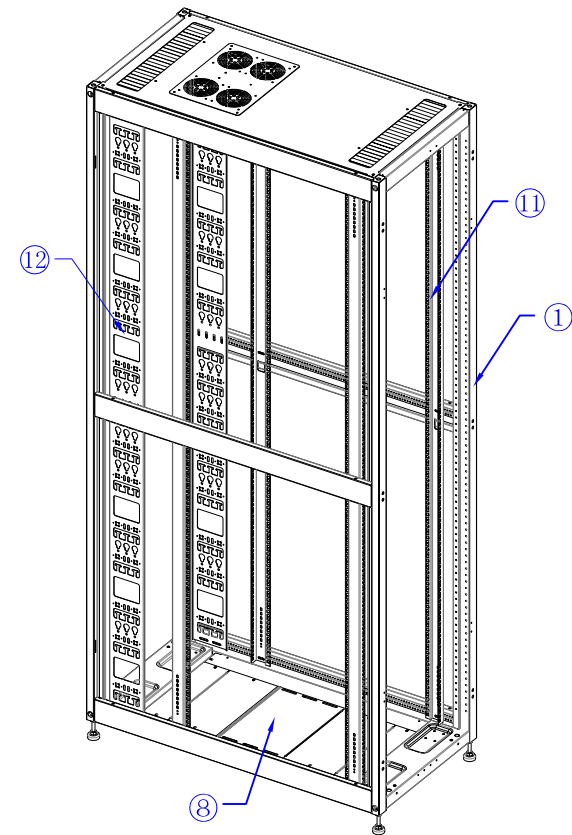
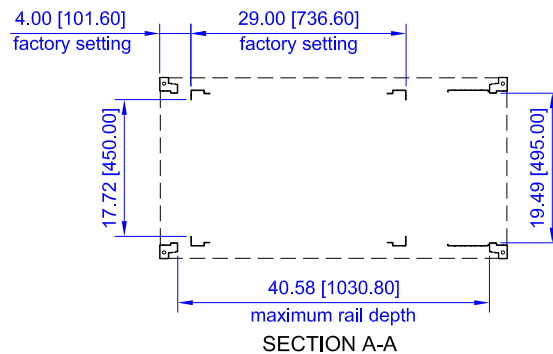

All dimensions in inches [mm]

ITEM NO.

VC5-6252-ABV1A

**VERICOM**

DESCRIPTION

Server Cabinet, 52U x 24"W x 48"D

DATE

05/12/20

SCALE

none

SHEET

2 of 2

REV

1