



Standard Single Gang F-81 Faceplates



Description / Specifications

Vericom standard single gang F-81 faceplates are molded out of proprietary impact resistant plastic. These faceplates provide quick connection and support for a single or a dual F-81 coaxial cable connection. These faceplates come complete with mounting screws.

Features & Benefits

- Pre-installed single or dual F-81 connectors
- Flush mounting for an aesthetic look
- For Satellite TV, Cable TV and CCTV applications
- Includes screws for mounting
- Available in Black, Ivory, Light Almond, or White

Applications

These standard single gang F-81 faceplates offer connectivity for most satellite, cable, and CCTV applications requiring a single gang size and are ideal for situations requiring a flush mount.

Ordering Information

TYPE	BLACK	IVORY	LIGHT ALMOND	WHITE
Single F-81, Single Gang	XFPOP-04716	XFPOP-00478	XFPOP-01449	XFPOP-00467
Dual F-81, Single Gang	XFPOP-04717	XFPOP-00479	XFPOP-01450	XFPOP-00468



Standard Single Gang F-81 Faceplates

Technical Drawing

Single F-81

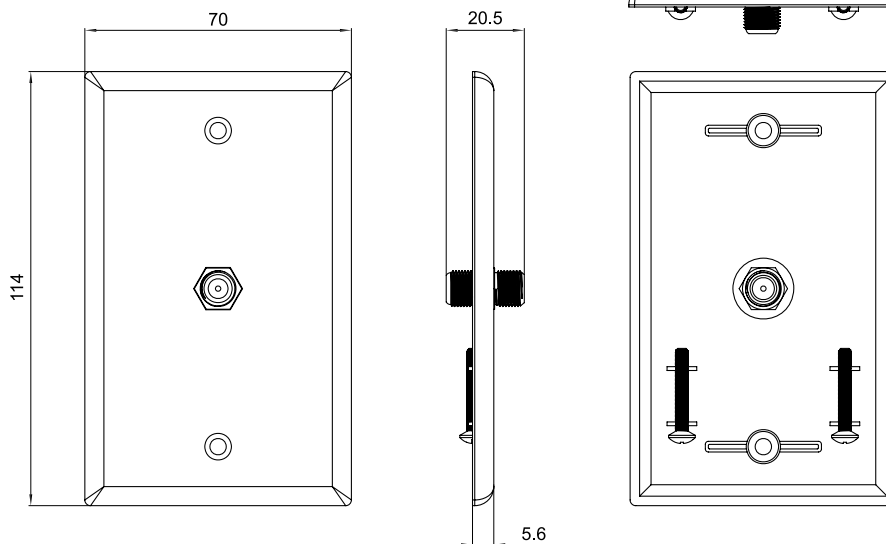

Dual F-81

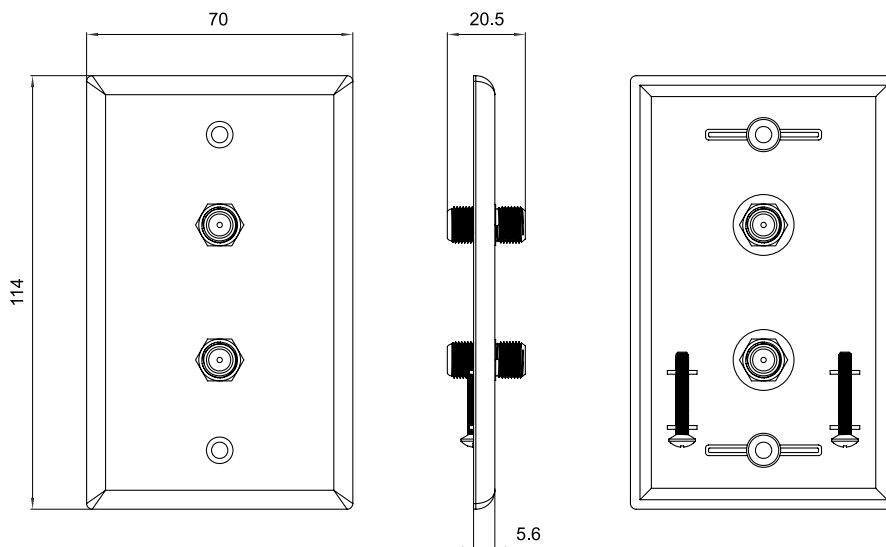

Physical Specifications

# of RJ-14 Ports	1 Port	2 Port
Dimensions	114*70*20.5 mm	114*70*20.5 mm
Material	High Impact, Fire retardant ABS plastic rated UL94V-0	
Mounting	Screws (Included)	
Color	Black, Ivory, Light Almond, or White (see ordering information)	

TECHNICAL SHEETS ARE SUBJECT TO CHANGE WITHOUT NOTICE.

REV.20250106.3